

- ATEX and IEC Ex approved - Zone 1
- ABS approved
- Zone 2 variant and C1D2 variants (UL/CSA) available
- Retrofittable
- Ultra long life LED
- High lumen output LED
- Easy installation, maintenance and inspection
- Wide operating temperature range of -40° to +55°C
- Clear external tear off strips on outer optics available
- 5 year warranty

The SPARTAN Linear WL168-1500 is designed specifically for hazardous area environments/installations to retrofit existing 2x58W fluorescent luminaires to provide high performance, reliable, White-Light illumination. With a reduction in consumption from 116W (2x58W) to SPARTAN's 68W, a saving of 41% per fitting, the WL168-1500 offers significant energy savings and cost reductions over larger installations. Housed in Marine Grade aluminium and using Raytec's field-proven, long-life LED technology, SPARTAN Linear is ATEX and IEC Ex approved for all Zone 1 applications, and rated for T4, T5 and T6 environments (Zone 2 variants also available). SPARTAN Linear's overall dimensions, fixing centres and gland entries are all compatible with commonly used traditional Ex e 2x58W fluorescent luminaires. The lumen output and light distribution also allows a direct, easy replacement of traditional fluorescent luminaires, meaning the customer can upgrade without complication and enjoy all the benefits of long life LED lighting while making regular lamp changes redundant and achieving large energy savings.

SPARTAN WL168-1500 Linear is available as a standard version only. The unique modular design means key components can be easily accessed and serviced if required to make inspection and maintenance quicker and easier. SPARTAN Linear has a clear polycarbonate diffuser which is also available in various degrees of opaqueness to provide greater flexibility during installation. SPARTAN uses **COOLEXTRUDE™** thermal management technology, ensuring a much cooler LED operating temperature and up to 60% better heat dissipation compared to traditional lighting solutions, allowing the product to operate for > 10 years while still delivering a high lumen output of up to 6,240 lumens.

Product Dimensions

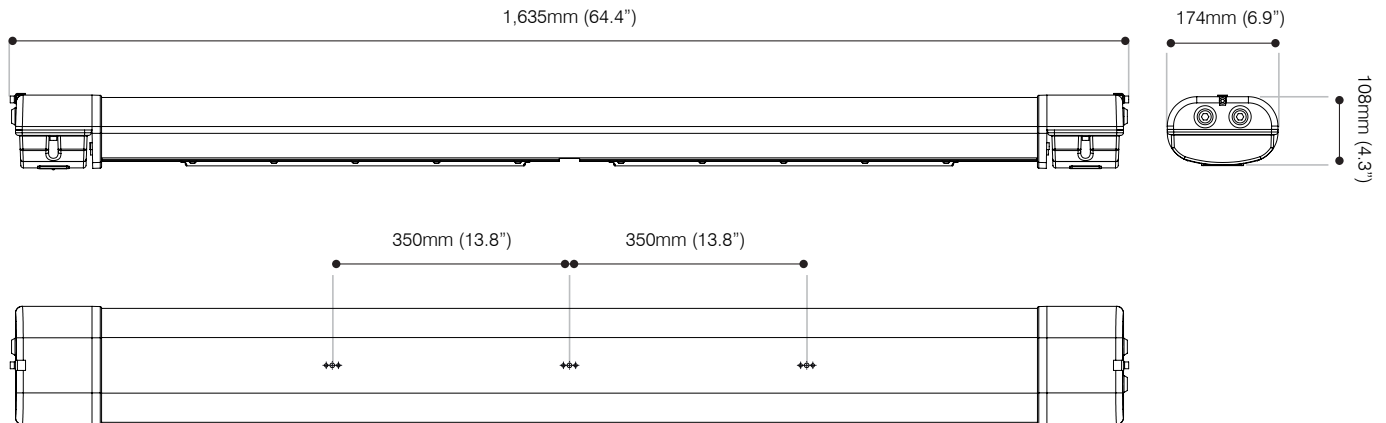

Features	Benefits
Ultra-Powerful	High lumen output – up to 6,240 lumens Latest high power LED technology
Retrofitable	Easy installation, matching the dimensions of traditional 2 x 58W fluorescent fittings, to provide an easy direct replacement Equivalent Output to 2 x 58W fluorescent
Ultra-Reliable	Industry leading 5 year warranty Designed and manufactured in the UK to the highest standards including both ISO9001 & ISO14001 Advanced electronics and LED's protected by vibration resistant and waterproof potting compound
Ultra-Modular	Both the LED and PSU modules are easily accessible for maintenance and inspection Available as a standard fitting only
Ultra-Efficient	COOLEXTRUDE™ thermal management delivers class leading energy efficiency Significant running and maintenance savings compared to traditional lighting technologies SMART access wiring system for safe and efficient installation, set-up and ongoing inspection
Ultra-Support	Photometric files available (.ies & .ldt) Full Lighting Design Service Site specific Energy and Cost Saving Report available

5 YEAR WARRANTY

All Raytec luminaires are provided with an industry leading 5 year warranty and have an expected useful life in excess of 10 years



Technical Specifications

Certification

ATEX Rating:	ATEX and IEC Ex rated for Gas and Dust
Hazardous Area rating:	Zone 1 – Gas and Dust
Certificates:	CML13ATEX3119 & IEC Ex CML 15.0001 UL/CSA, including C1D2
Gas:	II2 G D Ex e mb IIC T4 Gb Ta= -40°C to +55°C
Dust:	Ex tb IIIC T75°C Db Ta= -40°C to +55°C
ABS Rating:	ABS Certificate # 20-1990083-PDA

Electrical

Input:	110-254V 50/60Hz AC only Low voltage: 18-48V AC and 18-69V DC Extra low voltage: 12V AC/DC
Power:	Standard - 59W
Termination	Incoming terminal block suitable for looping 4 core 4mm ² cable (6mm ² available - POA)
Power Factor:	>0.95
Cable Entries	2xM20 as standard (other entries available upon request), dispatched complete with one ATEX/IEC Ex approved blanking plug

Optical

Lumen output on mains:	Up to 6,240 lm
LED type:	Platinum Elite SMT LEDs
Number of LEDs:	168 LEDs
CRI	80+
Colour Temperature:	6,000K+

Mechanical/Environmental

Burning position:	Universal
IP rating:	IP66 & IP67
Temperature range:	-40°C to +55°C
Weight:	Standard - 9kg (19.8lbs)
Enclosure:	Marine grade aluminium epoxy powder coated, UV stabilised polycarbonate, all external fasteners and brackets are marine grade stainless steel
Unit Colour:	Silver (RAL 9006)
Installation instructions:	Please see document 910-M-0284 at www.raytecl.com
Battery care instructions:	Please see document 0010-D-00001 at www.raytecl.com
Dimensions:	Standard - 1635 x 108 x 174mm (64.4 x 4.3 x 6.9")
Mounting:	Via M8/M6 tapped holes. Various mounting arrangements available (please see product overview guide)



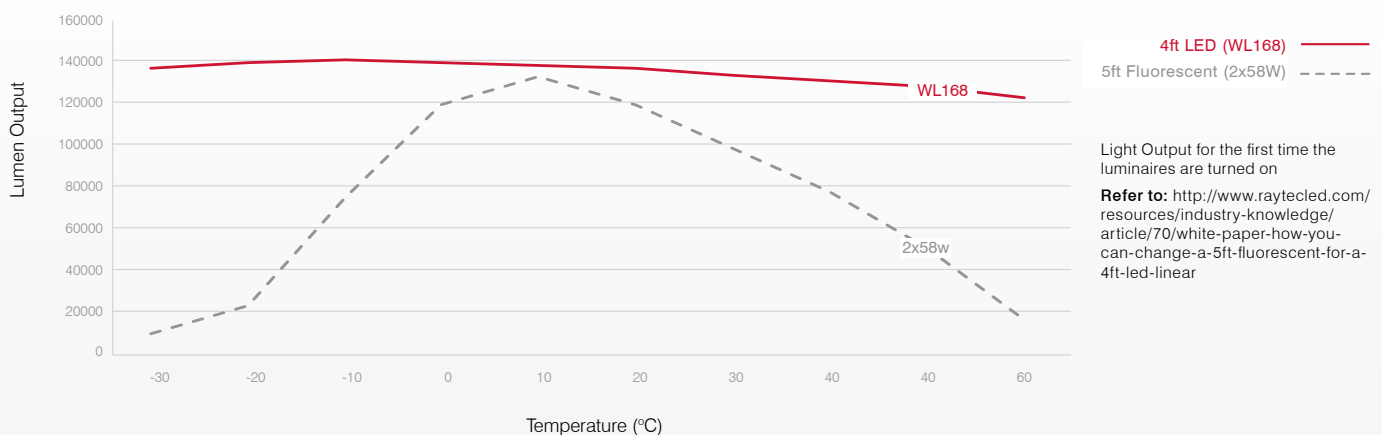



Light Output



Part Codes

Part Codes	Description
SPX-WL168-1500	SPARTAN Zone 1 Linear, 168 LED, White-Light

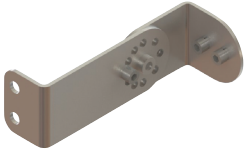
SPARTAN Linear Accessories

 <p>SUSPENSION CORD KIT</p>	 <p>POLE CLAMP KIT</p>	 <p>M8 EYE BOLT</p>
<p>SPX - BKT - SC500 (500mm Long, Stainless Steel) SPX - BKT - SC1000 (1000mm Long, Stainless Steel) SPX - BKT - SC1500 (1500mm Long, Stainless Steel)</p>	<p>SPX - BKT - PC3841 (38-41mm Diameter, Stainless Steel) SPX - BKT - PC4245 (42-45mm Diameter, Stainless Steel) SPX - BKT - PC4851 (48-51mm Diameter, Stainless Steel) SPX - BKT - PC5457 (54-57mm Diameter, Stainless Steel) SPX - BKT - PC5962 (59-62mm Diameter, Stainless Steel)</p>	<p>SPX - BKT - EYE (Stainless Steel)</p>
 <p>CEILING MOUNTING KIT</p>	 <p>SWIVEL MOUNT KIT</p>	 <p>WALL MOUNTING OUTREACH BRACKET</p>
<p>SPX - BKT - CM (Stainless Steel)</p>	<p>SPX=BKT-SW (30° and 45° Increments, Stainless Steel)</p>	<p>SPX - BKT - WMOB84 SPX - BKT - WMOB168</p>

Other accessories also available, including Magnetic Mounting Kit (SPX-BKT-MAG) and Tear Off Optic Strips - pack of 10 (SPX-BKT-PF84)

Products in the SPARTAN Linear WL168-1500 range

Zone 1, Zone 2, UL/CSA, Industrial



Products in the SPARTAN Family

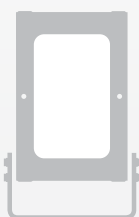

SPARTAN Flood



SPARTAN Linear

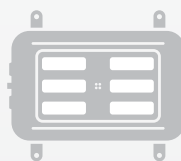

SPARTAN Bulkhead



SPARTAN Bay



SPARTAN Crane