



ExBin-P Pressure switches 5 Pa ... 5.000 Pa

Electrical, explosion-proof binary pressure/differential pressure switches

5 Pa...100 Pa with adjustable switch activation delay

24 VAC/DC supply voltage, output potential free switching contact

EC type-approved in acc. with ATEX directive 2014/34/EU for zone 1, 2, 21, 22

ExBin - P- ...
ExBin - P- ... - 2
ExBin - ... - CT
ExBin - ... - OCT
ExBin - ... - VA
ExBin - ... - OVA

Subject to change!

Compact. Easy installation. Universal. Cost effective. Safe.

Type	Switch	Supply	Range	min. Setting	max. Pressure	Activation delay	Output switch	Wiring diagram	
ExBin-P- 100	Pressure	24 VAC/DC	0... 100 Pa	5 Pa	5.000 Pa	0...240 s	potential free contact	SB 1.0	
ExBin-P- 500	Pressure	24 VAC/DC	0... 500 Pa	25 Pa	5.000 Pa	–	potential free contact	SB 1.0	
ExBin-P-5000	Pressure	24 VAC/DC	0...5.000 Pa	250 Pa	50.000 Pa	–	potential free contact	SB 1.0	
ExBin-P- ... - 2	Types ...P-500 und ...P-5000 as above with additional switching output							2 × potential free contact	SB 1.0
ExBin-P- ... - CT	Types as above with aluminium housing and seawater resistant coating (cable glands M16 brass nickel-plated, screws in stainless steel)								
ExBin-P- ... - OCT	Types as above, offshore version with aluminium housing and seawater resistant coating (stainless steel tubes for clamping ring connection, cable glands M20 brass nickel-plated, screws in stainless steel)								
ExBin-P- ... - VA	Types as above with stainless steel housing for aggressive ambient (cable glands M20 brass nickel-plated, screws in stainless steel)								
ExBin-P- ... - OVA	Types as above, offshore version with stainless steel housing for aggressive ambient (tubes for clamping ring connection and screws in stainless steel, cable glands M20 brass nickel-plated)								

Product views and applications

Figures ...Bin-P-...-2

Pressure/Diff. press. switch



...Bin-P-...-CT



...Bin-P-...-VA



Offshore ...-OCT



Offshore ...-OVA



Description

The ExBin-P-... pressure switch generation from 5...5000 Pa (acc. to type) is a revolution for differential pressure switches in HVAC systems, in chemical, pharmaceutical, industrial and offshore/onshore plants, for use in hazardous areas zone 1, 2 (gas) and zone 21, 22 (dust).

Highest protection class (ATEX) and IP66 protection, small dimensions, universal functions and technical data guarantee safe operation even under difficult environmental conditions.

All pressure switches are programmable on site without any additional tools. The switching points are scalable within the maximum ranges. The integrated display is for parametrisation and an actual value indication at working mode (can be switched off as needed).

...Bin-P-...-2 sensors are equipped with an additional switching output (2-stage), which can be parametrised independently.

...Bin-P-...-OCT and ...-OVA offshore versions are equipped with stainless steel tubing Ø 6 mm.

Highlights

- ▶ For all types of gases, mists, vapours and dust for use in zone 1, 2, 21 and 22
- ▶ Power supply 24 VAC/DC
- ▶ Potential free switching contact output
- ▶ Adjustable switching threshold, hysteresis and start-up bypass time
- ▶ Adjustable switch activation delay (acc. to type)
- ▶ Integrated Ex-e terminal box
- ▶ No additional Ex-i module required
- ▶ No intrinsically safe wiring/installation between panel and sensor required
- ▶ No intrinsically safe wiring/installation and no space in the panel required
- ▶ Optional second switching output (acc. to type)
- ▶ Display with backlight, can be switched off
- ▶ Password locking
- ▶ Down to -20 °C ambient temperature applicable
- ▶ Compact design and small dimension
- ▶ Robust aluminium housing (optional with seawater resistant coating) or in stainless steel
- ▶ IP66 protection
- ▶ Offshore versions with pressure tube connection for clamping ring Ø 6 mm



Technical data	...-P-100	...-P-500	...-P-5000
Supply voltage, frequency	24 VAC/DC ±20 % (19,2...28,8 VAC/DC), 50/60 Hz		
Current, power consumption	150 mA, ~ 4 W, internal fuse 500 mA, without bracket, not removable		
Galvanic isolation	Supply for relay output min. 1,5 kV		
Electrical connection	Terminals 0,14...2,5 mm ² at integrated Ex-e terminal box, stripping length 9 mm, torque 0,4...0,5 Nm, equipotential bonding 4 mm ²		
Cable glands	2 × M16 × 1,5 mm, Ex-e approved, for cable diameter ~ Ø 5...9 mm		
Cable glands ...-CT	2 × M16 × 1,5 mm, Ex-e approved, brass nickel-plated, for cable diameter ~ Ø 6...10 mm		
...-VA, ...-OCT, ...-OVA	2 × M20 × 1,5 mm, Ex-e approved, brass nickel-plated, for cable diameter ~ Ø 6...13 mm		
Protection class	Class I (grounded)		
Display	LC-Display, backlit, for configuration, user guidance, parameter and actual value indication. Status indicator via LEDs		
Control elements	3 buttons for configuration		
Housing material	Aluminium die-cast housing, coated, Optional with seawater resistant coating (...-CT/...-OCT) or stainless steel housing, № 1.4581 / UNS-J92900 / similar AISI 316Nb (...-VA/...-OVA)		
Dimensions (L × W × H)	Aluminium housing ~ 180 × 107 × 66 mm, stainless steel housing ~ 195 × 127 × 70 mm (each without connectors)		
Weight	~ 950 g aluminium housing, stainless steel version ~ 2,5 kg		
Ambient temperature	-20...+50 °C, storage temperature -35...+70 °C		
Temperature class	Aluminium housing T6 (T80 °C) at -20...+50 °C Stainless steel housing T5 (T95 °C) at -20...+40 °C, T4 (T130 °C) at -20...+50 °C		
Ambient humidity	0...95 % rH, non condensing		
Sensor circuit	Internal intrinsically safe (IS) circuit		
Sensor	Piezo pressure transmitter, installation in Ex zone		
Pressure connection	P+ / P- sleeves Ø 4...6 mm. OCT versions have 2 stainless steel (316L) tube connections for clamp ring fittings Ø 6 mm		
Measuring range	0...100 Pa	0...500 Pa	0...5000 Pa
	Minimum measuring range is 5 % of full range (e.g. 25 Pa at ...500 Pa switch)		
Response time of sensor	T90 / 5 s		
Accuracy of pressure	< ±1 % typically, max. ±5 % of end value ±1 Pa		
Setting range hysteresis	0,1...10 Pa (factory setting 2 Pa)	0,5...50 Pa (factory setting 10 Pa)	5...500 Pa (factory setting 100 Pa)
Start delay	5 s		
Start-up bypass time (AUB)	3...240 s (factory setting 120 s)		
Switch activation delay	0...240 s (factory setting 0 s / Off)	–	–
Setting zero point	Via menu. Short-circuit mechanically both tube connectors P+ / P- for the moment of zero point setting		
Output	Potential free switching contact – breaking / making contact, adjustable per menu max. rating load: 0,5 A (30 VAC/DC) – 0,1 A (250 VAC) – 0,1 A (220 VDC); min. rating load: 10 mW / 0,1 V / 1 mA		
Additional relay output (type ...-2)	–	as above	as above
Duration of life Mechanical	10 × 10 ⁶		
Electrical (rated load)	100 × 10 ³		
Wiring diagram	SB 1.0		
Scope of delivery	Pressure switch, 3 self-tapping screws 4,2 × 13 mm resp. in stainless steel (with ...CT and ...VA versions), short circuit tube		

Approbations

ATEX directive	2014/34/EU
EC type-approved	EPS 14 ATEX 1 657
IECEX certified	IECEX EPS 14,0074
Approval for gas	II 2 (1) G Ex e mb [Ia Ga] IIC T6...T4 Gb
Types ...-CT, ...-OCT	II 2 (1) G Ex e mb [Ia Ga] IIB T6 Gb
Approval for dust	II 2 (1) D Ex tb [Ia Da] IIIC T80°C...T130°C Db IP66
CE identification	CE № 0158
EMC directive	2014/30/EU
Enclosure protection	IP66 in acc. with EN 60529
EAC	TC RU C-DE.ГБ08.В.01510

Special solutions and accessories

...-CT	Types in aluminium housing with seawater resistant coating, parts nickel-plated
...-OCT	Offshore version in aluminium housing with seawater resistant coating, parts nickel-plated
...-VA	Types in stainless steel housing, parts nickel-plated
...-OVA	Offshore version in stainless steel housing, parts nickel-plated
MKR	Mounting bracket for round ducts up to Ø 600 mm
Kit 2	Flexible pressure tube, 2 m, inner Ø 6 mm, 2 connection nipples
Kit-S8-CBR	2 cable glands M16 × 1,5 mm, Ex-e, brass nickel-plated, for cable Ø 5...10 mm
Kit-Offs-GL-CBR	2 cable glands M20 × 1,5 mm, Ex-d, Ms-Ni, for armoured cables
Kit-PTC-CBR	2 connecting tubes for tube fittings Ø 6 mm, stainless steel 316 L



Electrical connection

All pressure switches require a 24 VAC/DC power supply. The electrical wiring must be realized via the integrated Ex-e terminal box acc. to ATEX. The terminals' type of protection is "Increased safety Ex-e".

Attention: Before opening the terminal box cover, the supply voltage must be shut off!

The supply has to be connected at terminals 1 (-/-) and 2 (+/-).

The start-up bypass delay (AUB) can be activated by bridging terminals 2–3. Activation is indicated by a flashing green LED.



At different relay and supply voltages (24 VAC/DC) the cable installation must be considered (see "Information for Installation")!



ExBin-P...

SB 1.0

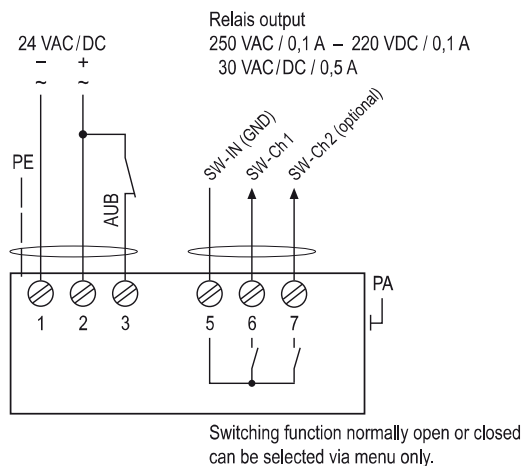

Zero point compensation

...Bin-P... pressure switches are equipped with a zero point compensation to adjust the module to the installation position. The pressure nipples P+ / P- must be connected with a short circuit tube and the zero point compensation performed by following the menu for parametrisation (menu 14).

Before starting the zero point compensation, the device should be connected to power supply for a minimum of 15 minutes to reach the uniform working temperature!

Display, buttons and parameters



Change operation – parametrisation mode

To change from operation to parametrisation mode and vice versa, push ENTER button for minimum of 3 seconds. Back to operation mode with menu "save".

Indication of data logging

A flashing unit symbol (star) in the display shows that data is received and the device is working.

Password input

The default/delivery setup is 0000. In this configuration the password input is not activated. To activate the password protection (menu 15) change the 4 digits into your chosen numbers (e.g. 1234) and press ENTER.

Please keep your password in mind for next parameter change! Due to a new parameter setup the password is requested.

Important information for installation and operation

A. Installation, commissioning, maintenance

All national and international standards, rules and regulations must be complied with. Certified apparatus must be installed in accordance with manufacturer instructions. If the equipment is used in a manner not specified by the manufacturer, the safety protection provided by the equipment may be impaired. For electrical installations design, selection and erection, EN/IEC 60079-14 can be used.



Attention: Apply all Ex rules and regulation before opening the internal terminal box. Do not open cover when circuits are live!

Draw the wiring cables through the cable glands. For connection use the internal Ex-e approved terminal box and connect equipotential bonding.

After connection install the cables in a fixed position and protect them against mechanical and thermal damage. Close all openings and ensure IP protection (min. IP66).

Avoid temperature transfer and ensure not to exceed max. ambient temperature! For outdoor installation a protective shield against sun, rain and snow should be applied.

After mounting and installation a zero point compensation must be done to ensure correct measurement results (see description).

Sensors are maintenance free. An annual inspection is recommended. For electrical installations inspection and maintenance, EN/IEC 60079-17 can be used.

Clean with damp cloth only.

Ex sensors must not be opened and repaired by the end user.

B. Long cabling

We recommend using shielded signal wires and to connect one end of the shield to the ...Bin... terminal box.

C. Separate ground wires

For supply and signal wires use separate grounds.

D. Relais output

Wires for safety extra-low voltage must be installed separately from other circuits. At 24 VAC/DC only supply and signal wires are permitted in one cable, in all other cases use separate or double isolated cables. An over-current protection fuse < 10 A has to be provided by the installer.



Dimensions [mm]

Aluminium housing

...Bin-P...-OCT

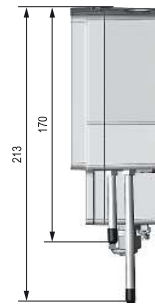
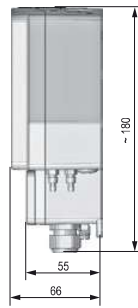
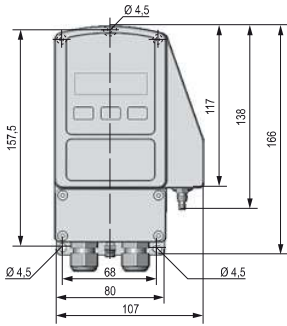

Stainless steel housing

...Bin-P...-OVA

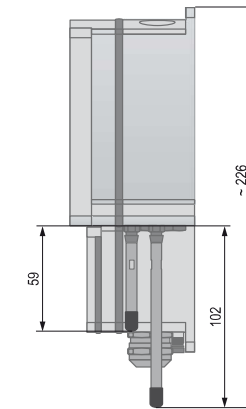
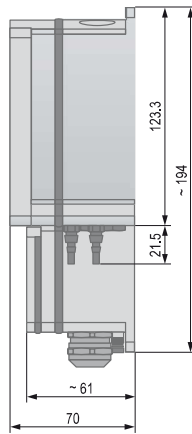
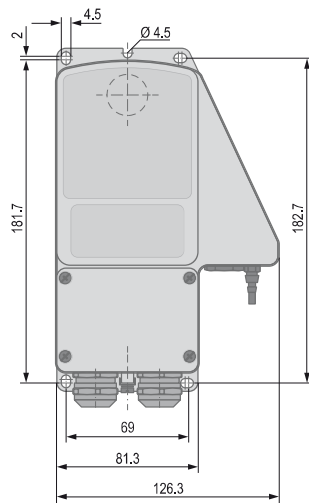

Parametrisation and commissioning

To change from operation to parametrisation mode push the "ENTER" button for minimum 3 seconds. If password protected: type password and push. Skip menu with, back to operation mode with menu "save".

Operation -> Parametrisation push for min. 3 s



Table with 10 columns: Menu, Function, ENTER, Indication, Select, ENTER, Next indication, Select, ENTER, Next menu. It details 7 menu steps for setting up the device, including Preset application, Unit sensor, switching points, hysteresis, and mode.

Continue next page

ExBin-P_en V02 - 7-Apr-2017



Continue Parametrisation

Menu	Function	ENTER	Indication	Select	ENTER	Next indication	Select	ENTER	Next menu
Menu 8	no function – menu skip								
Menu 9	no function – menu skip								
Menu 10	no function – menu skip								
Menu 11	no function – menu skip								
Menu 12	time Select bypass (AUB) time				enter seconds for AUB				
Menu 13	display setting Select display				on, off				
Menu 14	Zero point compensation Sensor's calibration for its installation position								
Menu 15	security Select password protection				enter password				
Menu 16	save Select: save data, discard, back to menu, factory setting				Yes, no, menu, dset (default setting)	(operation mode after "save")			

* for ...Bin-P...-2 only (2-stage)

** adjustable in professional mode only (menu 1)

Menu 1 "pset" – Preset

For some applications you can select presetting to ease parametrisation. Besides fan belt („FAN“) and filter monitoring („FILT“) the professional mode („PRO“) is available for further applications.

Professional mode

Menu 1
PRO

When this mode is selected the switching properties can be set at will per menu 5 ("hysteresis") and 6 ("mode") acc. to requirements.

Fan speed monitoring

Menu 1
FAN

The preset "FAN" hides menu 5 ("hysteresis") and 6 ("mode") during parametrisation. The corresponding values are set automatically.

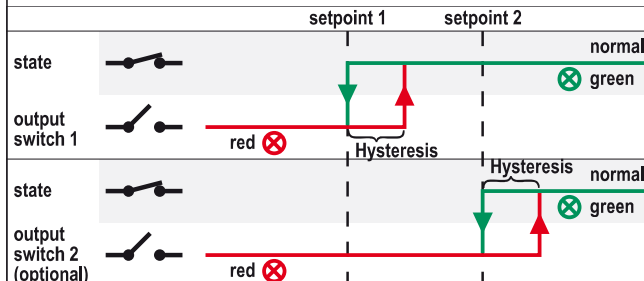
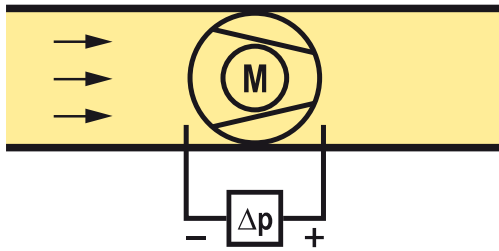

Filter monitoring

Menu 1
FILT

The preset "FILT" hides menu 5 ("hysteresis") and 6 ("mode") during parametrisation. The corresponding values are set automatically.

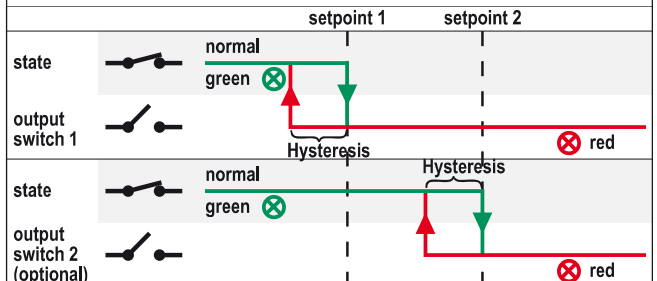
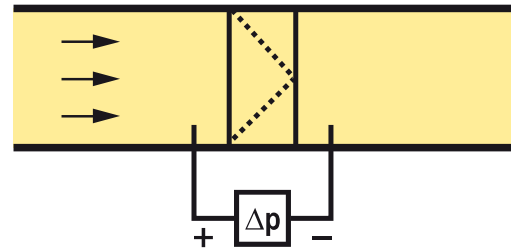



Menu 6 "mode" – Switching properties

1. Define the device's normal range first:

The device should indicate (green LED) when the pressure is

- above the setpoints – mode „up-range“ has to be selected.
- under the setpoints – mode „down-range“ has to be selected.
- between the setpoints – mode „mid-range“ has to be selected.

This mode is available for 2-stage devices only (...Bin-P...-2).

2. Select the switching characteristic of the output relay:

When the measured value is in normal range, the corresponding relays shall

- close – select "normally closed" (nc)
- open – select "normally open" (no)

