



RECESSED SPOTLIGHT 4.0202

UNDERWATER

IP68



- › New development
- › Up to 4600 lumen light intensity
- › Ideal for hotel pools and private pools

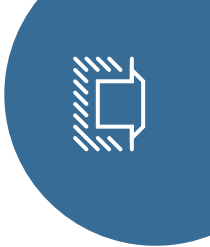

4.0202 | SWIMMINGPOOL-LIGHT

FOR ILLUMINATING SMALL AND MEDIUM SWIMMING POOLS.

IP68	STAINLESS STEEL V4A 1.4571 316Ti	POW-LED INCL.	3.000 K 4.500 K 6.000 K BLUE	RGB-W	CONSTANT CURRENT KONSTANT STROM	DALI 1-10 V OPTIONAL DIMM	CABLE INCL.	max 5m	↻	⏏	CE	III
------	--	---------------	---------------------------------------	-------	------------------------------------	------------------------------	-------------	--------	---	---	----	-----



NEW SERIES
CENTUM°°
 LIGHT UNDERWATER.
 REDEFINED.
 INFO ON PAGE 6



- Protection class IP68 – up to 5m water depth
- Entirely made of stainless steel 316Ti 1.4571, epolished
- Round attachment cover, made of stainless steel 316Ti, height 2 mm
- ...
- POW-LED cold white, warm white, neutral white
- POW-LED royal blue
- Multichip POW-LED RGB-W
- operating mode: constant current
- temperature controlled (onboard)
- surge protection
- rotationally symmetric wide light distribution
- ...
- Constant-current power source/RGB-W-controller ordered separately
- Installation housing made of stainless steel 316Ti with 1.5 m cable protection tube
- Supplied with 5 m of special underwater cable



+ ADDITIONAL PARTS

TIPP glass disc, frosted
 for softer light distribution (light loss approx. -15%)
50.4020.0002

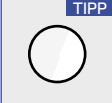



RECESSED SPOTLIGHT 4.0202

UNDERWATER

IP68



Installation housing

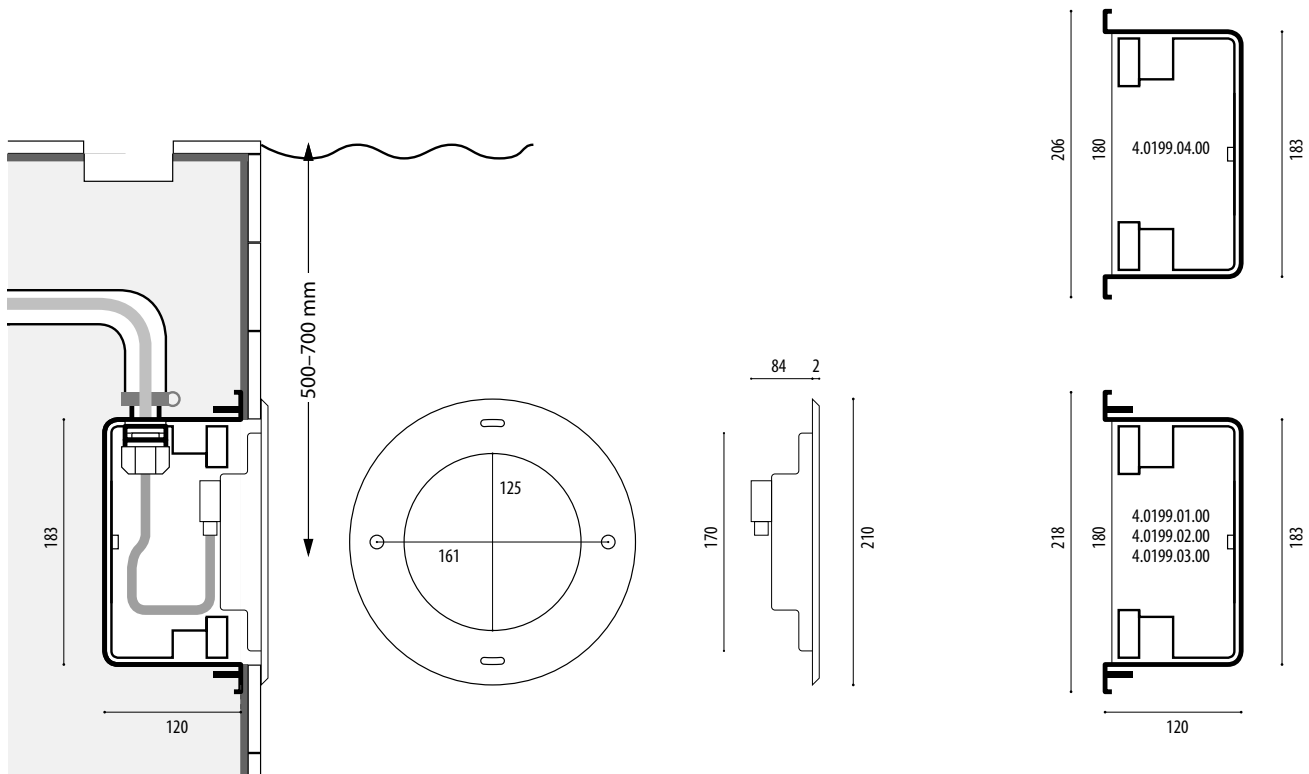

Article number	Lamps	Lumen	Light colour	Wattage	Current	Radation angle	Cable, installs
ONLY UNDERWATER OPERATION							
4.0202.00.11	8 POW-LED	4600 lm	6.000K cold white	total 31 W	CC 2400mA @12 V-DC	50° symmetrisch	UW, 2x2,5 qmm
4.0202.00.12	8 POW-LED	3760 lm	3.000K warm white	total 31 W	CC 2400mA @12 V-DC	50° symmetrisch	UW, 2x2,5 qmm
4.0202.00.13	8 POW-LED	4024 lm	4.500K neutral white	total 31 W	CC 2400mA @12 V-DC	50° symmetrisch	UW, 2x2,5 qmm
4.0202.00.16	8 POW-LED	500mW/LED	royal blue (450 nm)	total 33 W	CC 2400mA @12 V-DC	50° symmetrisch	UW, 2x2,5 qmm
4.0202.00.41	8 Multichip POW-LED	cold white: 1160 lm	RGB-CW cold white 6000K	all on 50 W	CC 700mA @12 V-DC	50° symmetrisch	UW, 10x0,5 qmm
4.0202.00.42	8 Multichip POW-LED	warm white: 1000 lm	RGB-WW warm white 3000K	all on 50 W	CC 700mA @12 V-DC	50° symmetrisch	UW, 10x0,5 qmm
4.0202.00.43	8 Multichip POW-LED	neutral white: 1080 lm	RGB-NW neutral white 4500K	all on 50 W	CC 700mA @12 V-DC	50° symmetrisch	UW, 10x0,5 qmm

INSTALLATION HOUSING

4.0199.01.00	made of V4A stainless steel with 1.5 m protective cable tube and M20 plastic terminating connection, for installation in concrete pools with tile covering
4.0199.02.00	made of V4A stainless steel with 1.5m protective cable tube and M20 plastic terminating connection, for installation in thin-walled pools and foil lined pools (pressure flange ø 218 mm)
4.0199.03.00	made of V4A stainless steel with 1.5 m protective cable tube and M20 plastic terminating connection, for installation in pools with adhesive/foil coating (adhesive flange ø 360 mm)
4.0199.04.00	made of V4A stainless steel with 1.5 m protective cable tube and M20 plastic terminating connection, for facing concrete and for welding into stainless steel pools



IP68

UNDERWATER

< Project
Private pool, Lucerne, Switzerland
Copyright: Timo Schwach Photography

NOTE

Matching installation housing should be selected, depending on the installation type and situation.

For facing concrete please use housing 4.0199.04.00

Power supplies Technical details see from page 234.

5.0630.10.08	
5.0630.10.08	Constant Current power supply, max 1 spotlights
5.0630.10.08	
5.0630.10.08	
5.0670.19.52	RGB-W-Controller, max 1 spotlights
5.0670.19.52	
5.0670.19.52	

OPTIONS

Possible beam angle POW-LED



POW-LED monochrome, single colour in green, red, amber, blue, capri blue, 2700K

Asymmetric light distribution especially for swimming pool lighting from a water depth of >1.80 m

Dynamic White possible (3000-6000°K)