



- › **Compact spotlight for variable use**
- › **Up to 1830 lumen light intensity**
- › **Perfect for fountains and water attractions**





4.0072 | SURFACE SPOTLIGHT

FOR ILLUMINATING AND ACCENTUATING OF FOUNTAINS, WATER FEATURES, BUILDINGS AND EXTERIOR AREAS.

○→○ CENTUM® Updated version available: 4.0100 – Page 44

IP68	STAINLESS STEEL V4A 1.4571 316Ti	ELECTRO POLISHED	POW-LED INCL.	3.000 K 4.500 K 6.000 K BLUE	RGB RGB-W	DYNAMIC WHITE	CONSTANT CURRENT KONSTANT STROM	DALI 1-10V OPTIONAL DIMM	CABLE INCL.	max 3m	180°	CE	III
------	--	------------------	---------------	---------------------------------------	--------------	------------------	------------------------------------	--------------------------------	-------------	--------	------	----	-----



- Protection class IP68 – up to 3m water depth
- Entirely made of stainless steel 316Ti 1.4571
- Mounting foot adjustable through 180°
- ...
- POW-LED cold white, warm white, neutral white
- POW-LED blue
- POW-LED RGB
- Multichip POW-LED RGB
- **NEW: Multichip POW-LED RGB-W**
- **NEW: Multichip POW-LED Dynamic white**
- operating mode: constant current
- Low voltage halogen QR-CB51 ES 12 V-AC
- Rotationally symmetric light distribution
- ...
- Screw-type cable fastener with M16x1.5, PVDF
- Constant-current power source/RGB controller/transformer external
- Supplied with lamp and 3m of underwater cable

+ ADDITIONAL PARTS



TIPP
Anti-glare ring
Stainless steel 316Ti,
ø 102 mm, length 124 mm
9.0072.00.70

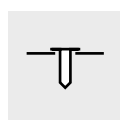

spike
stainless steel, 205 mm
9.0072.20.00



Mounting plate
V4A, ø125 mm, turnable +/-45°
9.0072.21.00

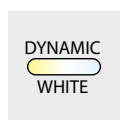

Control unit
Touch Control for dynamic white, DMX
5.0690.09.80



Mounting plate
V4A, ø170 x 10 mm, for easy installation
9.0072.22.00

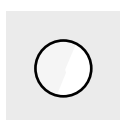

glass disc, frosted
for softer light distribution
(light loss approx. -15%)
9.0072.00.20

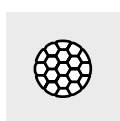

anti-glare louver
black, for 3 POW-LED and halogene
4.0071.00.50



anti-glare louver
black, for 6 POW-LED
4.0071.01.50

★ PRODUCT LINE

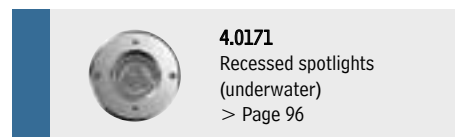



SURFACE SPOTLIGHT 4.0072

UNDERWATER | EXTERIOR

IP68



With Mounting plate

Spike

Anti-glare ring

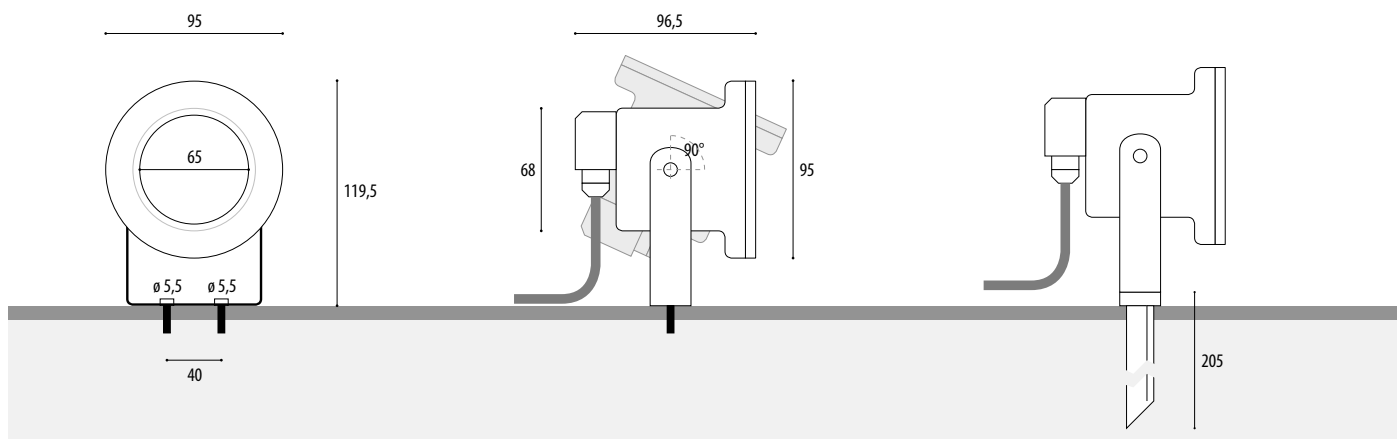

Article number	Lamps	Lumen	Light colour	Wattage	Current	Radiation angle	Cable, installs	[V]
----------------	-------	-------	--------------	---------	---------	-----------------	-----------------	-----

VERSIONS: UNDER- AND OVERWATER OPERATION (ACCORDING TO PRIOR AGREEMENT)

POW-LED, RADATION ANGLE SPOT

4.0072.00.01	3 POW-LED	495 lm	6000K cold white	total 5 W	CC 350 mA	10° spot	UW, 2x1,5 qmm	V32
4.0072.00.02	3 POW-LED	405 lm	3000K warm white	total 5 W	CC 350 mA	10° spot	UW, 2x1,5 qmm	
4.0072.00.03	3 POW-LED	465 lm	4500K neutral white	total 5 W	CC 350 mA	10° spot	UW, 2x1,5 qmm	
4.0072.00.06	3 POW-LED	400 mW/LED	blue	total 5 W	CC 350 mA	10° spot	UW, 2x1,5 qmm	
4.0072.00.09	3 POW-LED		RGB	all on 5 W	CC 350 mA	10° spot	UW, 6x0,5 qmm	

POW-LED, RADATION ANGLE MEDIUM

4.0072.00.11	3 POW-LED	495 lm	6000K cold white	total 5 W	CC 350 mA	30° medium	UW, 2x1,5 qmm	V33
4.0072.00.12	3 POW-LED	405 lm	3000K warm white	total 5 W	CC 350 mA	30° medium	UW, 2x1,5 qmm	
4.0072.00.13	3 POW-LED	465 lm	4500K neutral white	total 5 W	CC 350 mA	30° medium	UW, 2x1,5 qmm	
4.0072.00.16	3 POW-LED	400 mW/LED	blue	total 5 W	CC 350 mA	30° medium	UW, 2x1,5 qmm	
4.0072.00.19	3 POW-LED		RGB	all on 5 W	CC 350 mA	30° medium	UW, 6x0,5 qmm	

HALOGEN

4.0072.00.20	QR-CBC51 (IRC)	300	3000K	20W	12V-AC	36°	UW, 2x1,5 qmm	C63
4.0072.00.35	QR-CBC51 (IRC)	620	3000K	35W	12V-AC	36°	UW, 2x1,5 qmm	C73

VERSIONS: ONLY UNDERWATER OPERATION

POW-LED, RADATION ANGLE SPOT

4.0072.30.01	3 POW-LED	915 lm	6000K cold white	total 9 W	CC 700 mA	10° spot	UW, 2x1,5 qmm	W61
4.0072.30.02	3 POW-LED	750 lm	3000K warm white	total 9 W	CC 700 mA	10° spot	UW, 2x1,5 qmm	
4.0072.30.03	3 POW-LED	855 lm	4500K neutral white	total 9 W	CC 700 mA	10° spot	UW, 2x1,5 qmm	
4.0072.30.06	3 POW-LED	630 mW/LED	blue	total 9 W	CC 700 mA	10° spot	UW, 2x1,5 qmm	
4.0072.30.09	3 POW-LED		RGB	all on 9 W	CC 700 mA	10° spot	UW, 6x0,5 qmm	
4.0072.30.21	6 POW-LED	1830 lm	6000K cold white	total 17 W	CC 1400 mA	10° spot	UW, 2x1,5 qmm	W11
4.0072.30.22	6 POW-LED	1500 lm	3000K warm white	total 17 W	CC 1400 mA	10° spot	UW, 2x1,5 qmm	
4.0072.30.23	6 POW-LED	1710 lm	4500K neutral white	total 17 W	CC 1400 mA	10° spot	UW, 2x1,5 qmm	
4.0072.30.29	3 Multichip POW-LED		RGB	all on 28 W	CC 700 mA	10° spot	UW, 6x0,5 qmm	

POW-LED, RADATION ANGLE MEDIUM

4.0072.30.11	3 POW-LED	915 lm	6000K cold white	total 9 W	CC 700 mA	30° medium	UW, 2x1,5 qmm	W33
4.0072.30.12	3 POW-LED	750 lm	3000K warm white	total 9 W	CC 700 mA	30° medium	UW, 2x1,5 qmm	
4.0072.30.13	3 POW-LED	855 lm	4500K neutral white	total 9 W	CC 700 mA	30° medium	UW, 2x1,5 qmm	
4.0072.30.16	3 POW-LED	630 mW/LED	blue	total 9 W	CC 700 mA	30° medium	UW, 2x1,5 qmm	
4.0072.30.19	3 POW-LED		RGB	all on 9 W	CC 700 mA	30° medium	UW, 6x0,5 qmm	
4.0072.30.31	6 POW-LED	1830 lm	6000K cold white	total 17 W	CC 1400 mA	30° medium	UW, 2x1,5 qmm	W12
4.0072.30.32	6 POW-LED	1500 lm	3000K warm white	total 17 W	CC 1400 mA	30° medium	UW, 2x1,5 qmm	
4.0072.30.33	6 POW-LED	1710 lm	4500K neutral white	total 17 W	CC 1400 mA	30° medium	UW, 2x1,5 qmm	
4.0072.30.39	3 Multichip POW-LED		RGB	all on 28 W	CC 700 mA	45° medium	UW, 6x0,5 qmm	
4.0072.30.43	1 Multichip POW-LED	neutral white: 140 lm	RGB-NW neutral white 4500K	all on 4 W	CC 350 mA	35° medium	UW, 8x0,5 qmm	
4.0072.30.80	1 Multichip POW-LED		3000K-6000K dynamic white	all on 4 W	CC 350 mA	35° medium	UW, 8x0,5 qmm	

HALOGEN

4.0072.30.50	QR-CBC51 (IRC)	870	3000K	50W	12V-AC	36°	UW, 2x1,5 qmm	C83
--------------	----------------	-----	-------	-----	--------	-----	---------------	-----

NEW



IP68

UNDERWATER | EXTERIOR



< Project
Norwegian Bank, Oslo, Norway

Power supplies Technical details see from page 234.

5.0635.65.03		5.0635.65.10		5.0635.65.20
5.0635.65.03	Constant Current power supply, max 1 spotlights	5.0635.65.10	Constant Current power supply, max 2 spotlights	5.0635.65.20
5.0635.65.03		5.0635.65.10		5.0635.65.20
5.0635.65.03		5.0635.65.10		5.0635.65.20
5.0635.65.03		5.0635.65.10		5.0635.65.20
5.0635.09.16	RGB-Controller, max 4 spotlights			

5.0635.65.03		5.0635.65.10		5.0635.65.20
5.0635.65.03	Constant Current power supply, max 1 spotlights	5.0635.65.10	Constant Current power supply, max 2 spotlights	5.0635.65.20
5.0635.65.03		5.0635.65.10		5.0635.65.20
5.0635.65.03		5.0635.65.10		5.0635.65.20
5.0635.65.03		5.0635.65.10		5.0635.65.20
5.0635.09.16	RGB-Controller, max 4 spotlights			

5.0098.00.00	Transformer, max 1 spotlights
5.0098.00.00	Transformer, max 1 spotlights

5.0670.65.10		5.0670.65.20
5.0670.65.10	Constant Current power supply, max 1 spotlights	5.0670.65.20
5.0670.65.10		5.0670.65.20
5.0670.65.10		5.0670.65.20
5.0670.09.18	RGB-Controller, max 6 spotlights	
5.0670.00.06		
5.0670.00.06	Constant Current power supply, max 1 spotlights	
5.0670.00.06		
5.0670.09.18	RGB-Controller, max 2 spotlights	

5.0670.65.10		5.0670.65.20
5.0670.65.10	Constant Current power supply, max 1 spotlights	5.0670.65.20
5.0670.65.10		5.0670.65.20
5.0670.65.10		5.0670.65.20
5.0670.09.18	RGB-Controller, max 6 spotlights	
5.0670.00.06		
5.0670.00.06	Constant Current power supply, max 1 spotlights	
5.0670.00.06		
5.0670.09.18	RGB-Controller, max 2 spotlights	
5.0635.09.52	RGB-W-Controller, max 12 spotlights	
5.0635.09.52		

5.0098.00.00	Transformer, max 1 spotlights
---------------------	-------------------------------

NOTE

 SALINE version possible - Article number with additional „S“ at the end

 POW-LED, series-connected

OPTIONS

Possible beam angle POW-LED

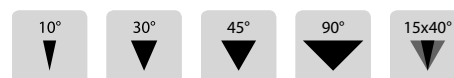

Possible beam angle HALOGENE



 POW-LED monochrome, single colour in green, red, amber, turquoise

Internal power supply available on request

230 V