

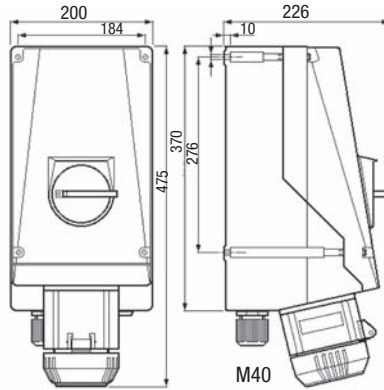

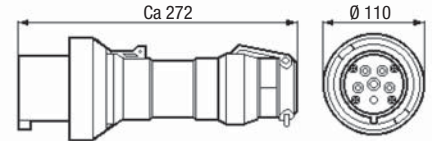



CEE-VÄGGUTTAG 63A, 220 – 690V



Zoner:







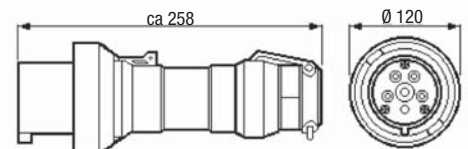
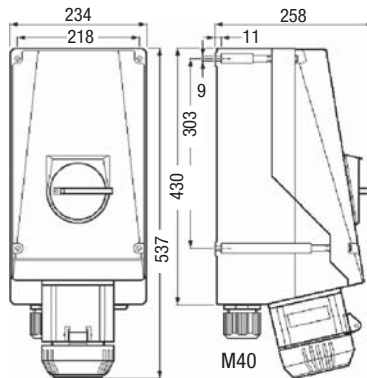

							PTB 00 ATEX 1070	
Art. nr	Utförande	Spänning V	Frekvens Hz	h ①	Typ nr	Vikt kg	Material	
550250	Vägguttag	220-240	50/60	9		GHG 514 4409 R0001	8,1	Polyester
550252	Stickpropp				GHG 514 7409 R0001	0,8	Polyamid	
550254	Vägguttag	380-415	50/60	6		GHG 514 4406 R0001	8,1	Polyester
550256	Stickpropp				GHG 514 7406 R0001	0,8	Polyamid	
550258	Vägguttag	500	50/60	7		GHG 514 4407 R0001	8,1	Polyester
550260	Stickpropp				GHG 514 7407 R0001	0,8	Polyamid	
550262	Vägguttag	690	50/60	5		GHG 514 4405 R0001	8,1	Polyester
550264	Stickpropp				GHG 514 7405 R0001	0,8	Polyamid	
550266	Vägguttag	380-415	50/60	6		GHG 514 4506 R0001	8,1	Polyester
550268	Stickpropp				GHG 514 7506 R0001	0,75	Polyamid	

① = Jordstiftsplacering.

CEE-VÄGGUTTAG 125A, 220 – 690V



							PTB 01 ATEX 1069	
Art. nr	Utförande	Spänning V	Frekvens Hz	h ①	Typ nr	Vikt kg	Material	
550280	Vägguttag	220-250	50/60	9		GHG 515 4409 R0001	13	Polyester
550282	Stickpropp				GHG 515 7409 R0001	0,9	Polyamid	
550284	Vägguttag	380-415	50/60	6		GHG 515 4406 R0001	13	Polyester
550286	Stickpropp				GHG 515 7406 R0001	0,9	Polyamid	
550288	Vägguttag	500	50/60	7		GHG 515 4407 R0001	13	Polyester
550290	Stickpropp				GHG 515 7407 R0001	0,9	Polyamid	
550292	Vägguttag	690	50/60	5		GHG 515 4405 R0001	13	Polyester
550294	Stickpropp				GHG 515 7405 R0001	0,9	Polyamid	
550296	Vägguttag	380-415	50/60	6		GHG 515 4506 R0001	13	Polyester
550298	Stickpropp				GHG 515 7506 R0001	0,9	Polyamid	

① = Jordstiftsplacering.